

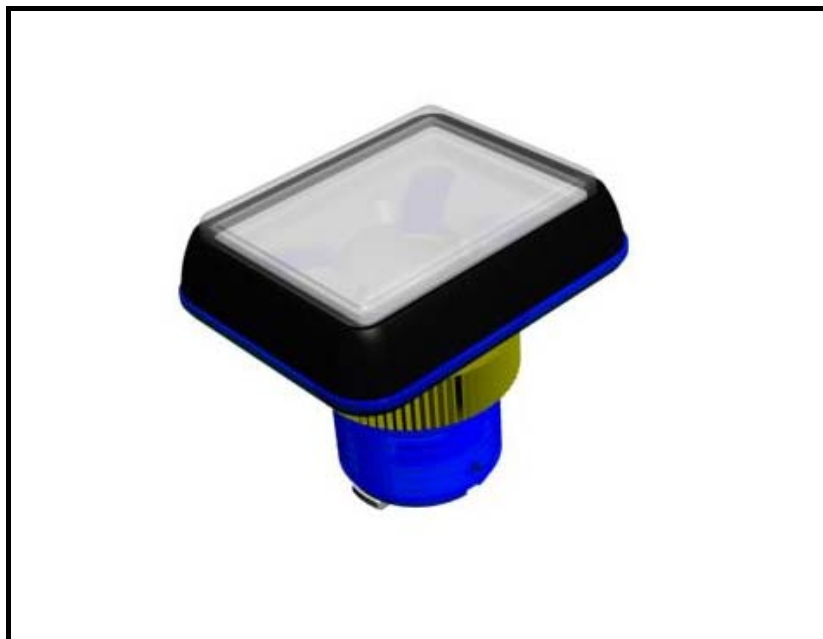

Gamesman

GPB320 Push Button Product Specification

Issue 02: Date 02.10.2015



Disclaimer:

The information provided within this product specification is intended only to make the reader aware of the product's technical data and its use thereof. As such, Gamesman Ltd shall not be held liable for any loss or damage to the assembly or component within, arising from its misuse or from the unintended use of information or particulars included within, or any omission from, this document.

Design and specifications are subject to change without notice.

Failure to observe the interface requirements specified in this document may result in damage to the electronics and resultant performance characteristics of the product.

1. Product Dimensions

a) General Dimensions

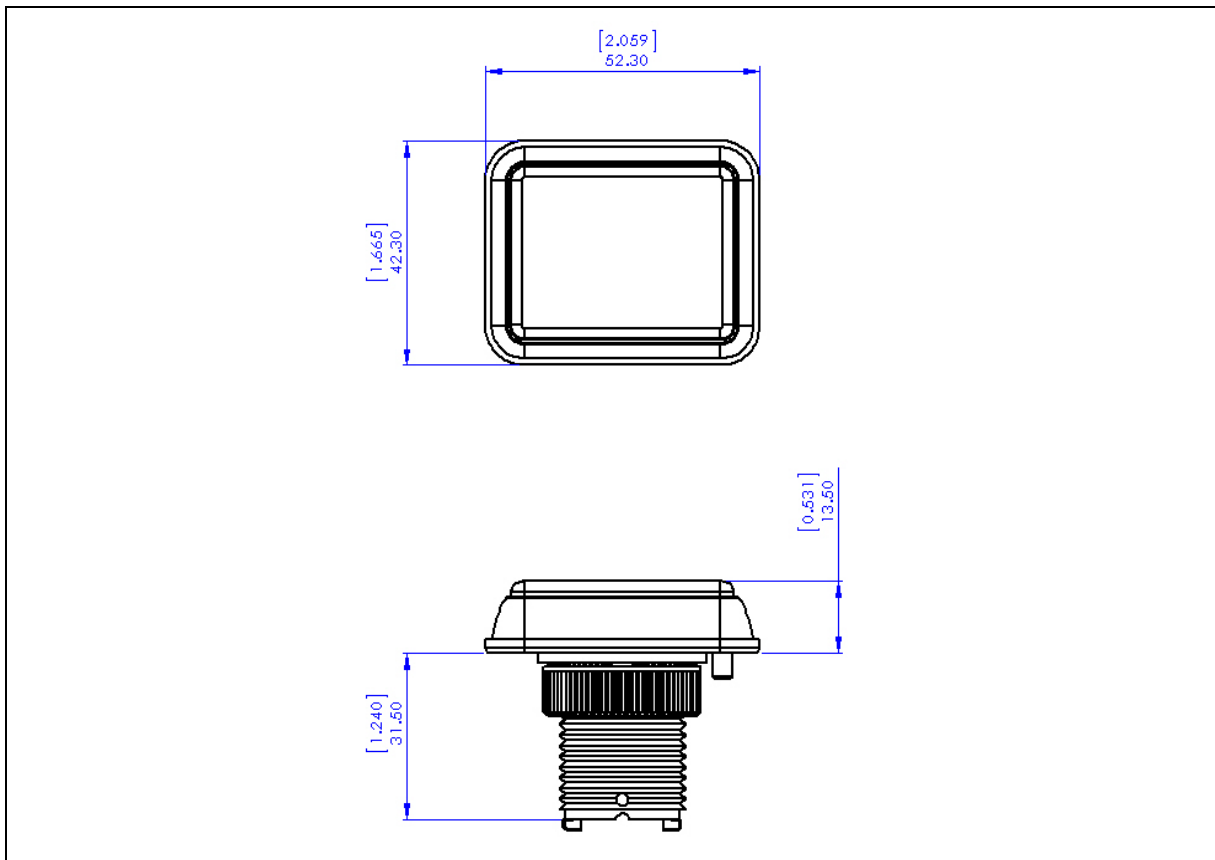

b) Insert Dimensions

c) Panel Cut out Details

<p>Technical drawing of an insert showing dimensions: width $[1.533]$ (38.95 MAX) and height $[1.140]$ (28.95 MAX).</p>	<p>Technical drawing of panel cut out details showing dimensions: diameter $[0.953 \pm 0.002]$ ($\varnothing 24.20 \pm 0.05$), diameter $[0.157 \pm 0.004]$ ($\varnothing 4.00 \pm 0.10$), and distance $[0.748 \pm 0.002]$ (19.00 ± 0.05).</p>
<p>Insert Material – Acetate sheet or similar.</p> <p>Insert Thickness – 0.2mm [0.008"] Minimum – 0.25mm [0.010"] Maximum</p>	<p>Panel thickness with standard nut: 20.00mm [0.787"] Maximum</p> <p>Panel thickness with Long Nut : 10.00mm [0.394"] Maximum</p>

2. Product Identification

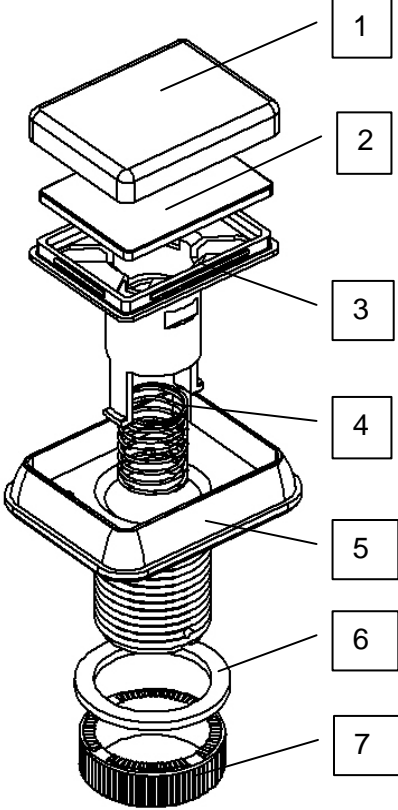
	No.	Part Number	Description	Material	UL94 Rating
	1	G3-301	Lens	Polycarbonate See Note 1.	HB
	2	G4-148	Legend Plate	Opal Polycarbonate	V2
	3	G3-304	Plunger	Opal POM	HB
	4	G4-330	Spring	Spring Steel	N/A
	5	Various	Dual Shot Bezel	Polycarbonate See Note 1.	V2
	6	G4-163	Washer	ABS	HB
	7	G4-145 *	Std. Nut	ABS	HB







Note 1. Component available in various colours/colour combinations, see specification sheet for the options. Minimum Order Quantities may apply.

* See section 4 – Accessories for an alternative long nut.

3. Product Compatibility – [Specification options GPB320 Spec Sheet.xls](#)



a) Switch Systems

<p>System S</p>		
<p>System JA – Standard Circuit</p>		
<p>System JC – NO Diode Circuit</p>		
<p>System RGB / BX The below LED and Lamp Solutions do not apply to this switch system.</p>		

b) LED Solutions





Volts	Colour
12v	White
12v	Blue
6.3v	White
3.3v	White

c) Lamp Solutions – T-3¼ - 10mm Lead Free Wedge Base Lamps

Volts	Current (mA)	Light Output (Lm)	Life (Hrs)
12v 0.1A	100	5.0	5,000
12v 2CP	200	22.6	1,000
24v 2CP	95	13	5,000

*All values are nominal

4. Accessories

<p>For an alternative long nut for quick release, please order Gamesman Part Number G3-589. If you would prefer the long nut with your push button, please specify in the comment section of the specification sheet.</p>	
<p>Nut Runner Tool for tightening to the recommended torque – please order Gamesman Part Number G3-499.</p>	

1. Specification Sheet

[Specification options GPB320 Spec Sheet.xls](#)



GAMESMAN LTD
CROMPTON FIELDS, CROMPTON WAY, CRAWLEY, WEST SUSSEX, RH10 9QB
TEL: +44 (0) 1293 418888 FAX: +44 (0) 1293 418880

REGISTERED IN ENGLAND No. 3027138

Website: www.gamesman.co.uk

E-mail: sales@gamesman.co.uk