



# Gamesman

## GPB110 Push Button Product Specification

Issue 01: Date 11.08.2011



Disclaimer:

The information provided within this product specification is intended only to make the reader aware of the product's technical data and its use thereof. As such, Gamesman Ltd shall not be held liable for any loss or damage to the assembly or component within, arising from its misuse or from the unintended use of information or particulars included within, or any omission from, this document.

Design and specifications are subject to change without notice.

Failure to observe the interface requirements specified in this document may result in damage to the electronics and resultant performance characteristics of the product.

1. Product Dimensions

a) General Dimensions

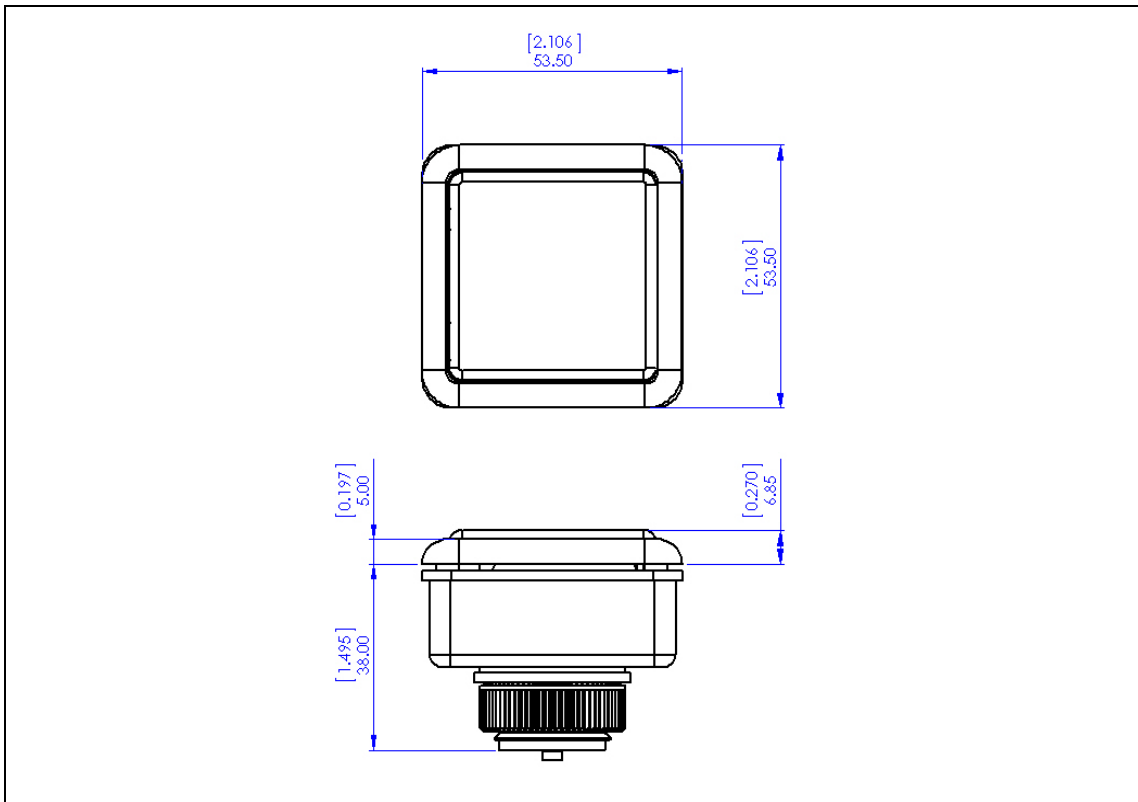

b) Insert Dimensions

c) Panel Cut out Details

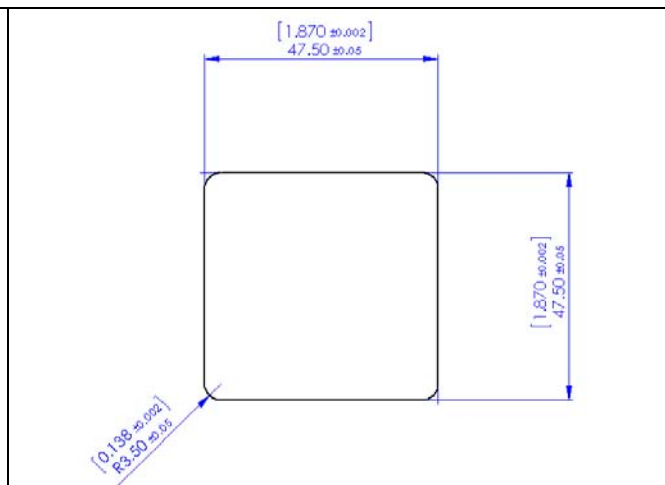
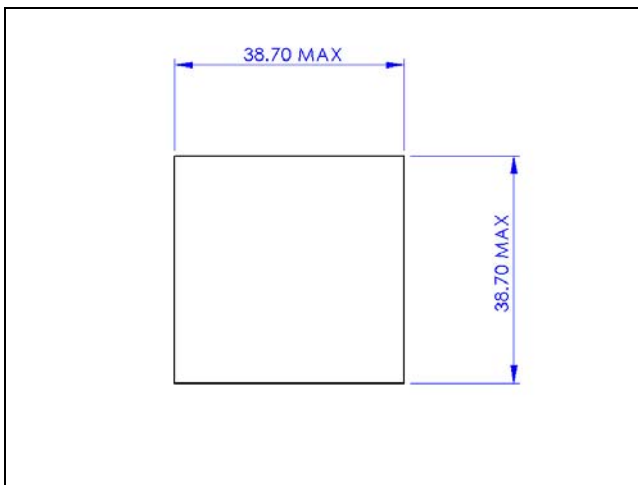

Insert Material – Acetate sheet or similar.

Insert Thickness – 0.2mm [0.008"] Minimum – 0.25mm [0.010"] Maximum

Panel thickness with standard nut: 5.00mm [0.787"] Maximum

## 2. Product Identification

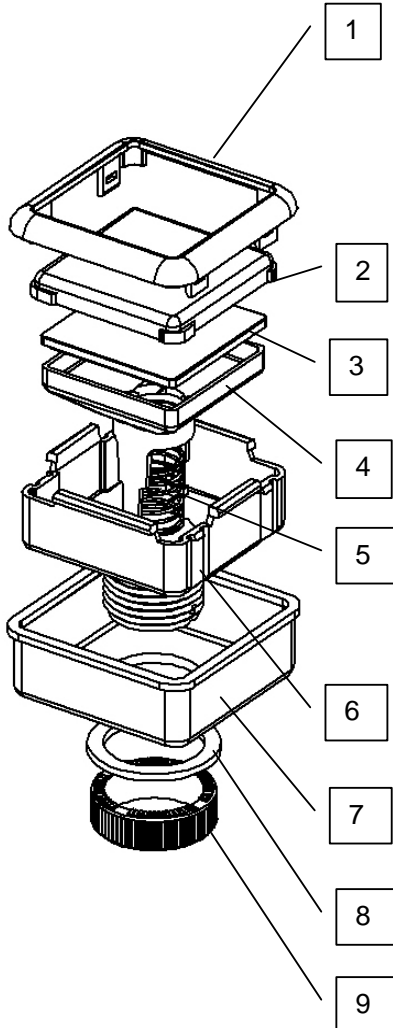





No.	Part Number	Description	Material	UL94 Rating
1	Various	Bezel	Polycarbonate See Note 1.	V2
2	G3-131-CR	Lens	Polycarbonate See Note 1.	HB
3	G4-147	Legend Plate	Opal Polycarbonate	V2
4	G3-134	Plunger	Opal POM	V2
5	G4-330	Spring	Spring Steel	N/A
6	G1-158	Body	ABS	HB
7	G3-141	Sleeve	ABS	HB
8	G4-163	Washer	ABS	HB
9	G4-145	Std. Nut	ABS	HB

Note 1. This part is available in various colours/colour combinations, see specification sheet for the options. Minimum Order Quantities may apply.

### 3. Product Compatibility

#### a) Switch Systems

<a href="#">System S</a>	
<a href="#">System A – Standard Circuit</a>	
<a href="#">System C – NO Diode Circuit</a>	
<a href="#">System F – Common Multiplex</a>	
<a href="#">System RGB</a>  The below LED and Lamp Solutions do not apply to this switch system.	

#### b) LED Solutions

Volts	Colour	ohms
12v	White	470ohm
12v	Red	470ohm
12v	Blue	390ohm
12v	White	604ohm
6.3v	White	187ohm
3.3v	White	0ohm

#### c) Lamp Solutions – T-3¼ - 10mm Lead Free Wedge Base Lamps

Volts	Current (mA)	Light Output (Lm)	Life (Hrs)
12v 0.1A	100	5.0	5,000
12v 2CP	200	22.6	1,000
24v 2CP	95	13	5,000

\*All values are nominal

4. Accessories

Nut Runner Tool for tightening to the recommended torque – please order Gamesman Part Number G3-499.

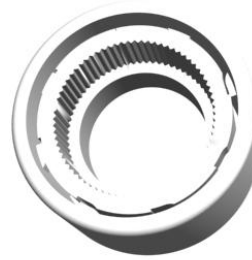

GAMESMAN LTD  
CROMPTON FIELDS, CROMPTON WAY, CRAWLEY, WEST SUSSEX, RH10 9QB  
TEL: +44 (0) 1293 418888 FAX: +44 (0) 1293 418880

**REGISTERED IN ENGLAND No. 3027138**

Website: [www.gamesman.co.uk](http://www.gamesman.co.uk)

E-mail: [sales@gamesman.co.uk](mailto:sales@gamesman.co.uk)